

# Inspiron 11

## 3000 Series

# Service Manual

Computer Model: Inspiron 11-3152  
Regulatory Model: P20T  
Regulatory Type: P20T003



# Notes, cautions, and warnings

---



**NOTE:** A NOTE indicates important information that helps you make better use of your computer.



**CAUTION:** A CAUTION indicates either potential damage to hardware or loss of data and tells you how to avoid the problem.



**WARNING:** A WARNING indicates a potential for property damage, personal injury, or death.

---

**Copyright © 2015 Dell Inc. All rights reserved.** This product is protected by U.S. and international copyright and intellectual property laws. Dell™ and the Dell logo are trademarks of Dell Inc. in the United States and/or other jurisdictions. All other marks and names mentioned herein may be trademarks of their respective companies.

2015 - 04

Rev. A00

# Contents

<b>Before working inside your computer.....</b>	<b>9</b>
Before you begin .....	9
Safety instructions.....	9
Recommended tools.....	11
<b>After working inside your computer.....</b>	<b>12</b>
<b>Removing the base cover.....</b>	<b>13</b>
Procedure.....	13
<b>Replacing the base cover.....</b>	<b>15</b>
Procedure.....	15
<b>Removing the battery.....</b>	<b>16</b>
Prerequisites.....	16
Procedure.....	16
<b>Replacing the battery.....</b>	<b>18</b>
Procedure.....	18
Post-requisites.....	18
<b>Removing the memory module.....</b>	<b>19</b>
Prerequisites.....	19
Procedure.....	19
<b>Replacing the memory module.....</b>	<b>21</b>
Procedure.....	21
Post-requisites.....	22

<b>Removing the hard drive.....</b>	<b>23</b>
Prerequisites.....	23
Procedure.....	23
<b>Replacing the hard drive.....</b>	<b>26</b>
Procedure.....	26
Post-requisites.....	26
<b>Removing the coin-cell battery.....</b>	<b>27</b>
Prerequisites.....	27
Procedure.....	27
<b>Replacing the coin-cell battery.....</b>	<b>29</b>
Procedure.....	29
Post-requisites.....	29
<b>Removing the wireless card.....</b>	<b>30</b>
Prerequisites.....	30
Procedure.....	30
<b>Replacing the wireless card.....</b>	<b>32</b>
Procedure.....	32
Post-requisites.....	33
<b>Removing the power and volume-buttons board.....</b>	<b>34</b>
Prerequisites.....	34
Procedure.....	34
<b>Replacing the power and volume-buttons board.....</b>	<b>36</b>
Procedure.....	36
Post-requisites.....	36

<b>Removing the speakers.....</b>	<b>37</b>
Prerequisites.....	37
Procedure.....	38
<b>Replacing the speakers.....</b>	<b>41</b>
Procedure.....	41
Post-requisites.....	41
<b>Removing the touch pad.....</b>	<b>42</b>
Prerequisites.....	42
Procedure.....	42
<b>Replacing the touch pad.....</b>	<b>46</b>
Procedure.....	46
Post-requisites.....	46
<b>Removing the processor fan and heat-sink assembly.....</b>	<b>47</b>
Prerequisites.....	47
Procedure.....	47
<b>Replacing the processor fan and heat-sink assembly.....</b>	<b>49</b>
Procedure.....	49
Post-requisites.....	49
<b>Removing the I/O board.....</b>	<b>50</b>
Prerequisites.....	50
Procedure.....	50
<b>Replacing the I/O board.....</b>	<b>52</b>
Procedure.....	52
Post-requisites.....	52

<b>Removing the system board.....</b>	<b>53</b>
Prerequisites.....	53
Procedure.....	53
<b>Replacing the system board.....</b>	<b>57</b>
Procedure.....	57
Post-requisites.....	58
Entering the Service Tag in the BIOS setup program.....	58
<b>Removing the power-adapter port.....</b>	<b>59</b>
Prerequisites.....	59
Procedure.....	59
<b>Replacing the power-adapter port.....</b>	<b>61</b>
Procedure.....	61
Post-requisites.....	61
<b>Removing the display assembly.....</b>	<b>62</b>
Prerequisites.....	62
Procedure.....	62
<b>Replacing the display assembly.....</b>	<b>65</b>
Procedure.....	65
Post-requisites.....	66
<b>Removing the palm rest and keyboard assembly.....</b>	<b>67</b>
Prerequisites.....	67
Procedure.....	67
<b>Replacing the palm rest and keyboard assembly.....</b>	<b>69</b>
Procedure.....	69
Post-requisites.....	69

<b>Removing the display back-cover and antenna assembly.....</b>	<b>70</b>
Prerequisites.....	70
Procedure.....	70
<b>Replacing the display back-cover and antenna assembly.....</b>	<b>72</b>
Procedure.....	72
Post-requisites.....	72
<b>Removing the display hinges.....</b>	<b>73</b>
Prerequisites.....	73
Procedure.....	73
<b>Replacing the display hinges.....</b>	<b>75</b>
Procedure.....	75
Post-requisites.....	75
<b>Removing the camera.....</b>	<b>76</b>
Prerequisites.....	76
Procedure.....	76
<b>Replacing the camera.....</b>	<b>78</b>
Procedure.....	78
Post-requisites.....	78
<b>Removing the Windows-button board.....</b>	<b>79</b>
Prerequisites.....	79
Procedure.....	79
<b>Replacing the Windows-button board.....</b>	<b>81</b>
Procedure.....	81
Post-requisites.....	81

<b>Removing the display cable.....</b>	<b>82</b>
Prerequisites.....	82
Procedure.....	82
<b>Replacing the display cable.....</b>	<b>85</b>
Procedure.....	85
Post-requisites.....	85
<b>Removing the display panel.....</b>	<b>86</b>
Prerequisites.....	86
Procedure.....	86
<b>Replacing the display panel.....</b>	<b>88</b>
Procedure.....	88
Post-requisites.....	88
<b>Flashing the BIOS.....</b>	<b>89</b>
<b>Getting help and contacting Dell.....</b>	<b>90</b>
Self-help resources.....	90
Contacting Dell.....	90





# Before working inside your computer

---

 **CAUTION:** To avoid damaging the components and cards, handle them by their edges and avoid touching pins and contacts.









 **NOTE:** The images in this document may differ from your computer depending on the configuration you ordered.

## Before you begin

- 1 Save and close all open files and exit all open applications.
  - 2 Shut down your computer.
    - Windows 8.1: On the **Start** screen, click or tap the power icon  → **Shut down**.
    - Windows 7: Click or tap **Start** → **Shut down**.
-  **NOTE:** If you are using a different operating system, see the documentation of your operating system for shut-down instructions.
- 3 Disconnect your computer and all attached devices from their electrical outlets.
  - 4 Disconnect all cables such as telephone cables, network cables and so on, from your computer.
  - 5 Disconnect all attached devices and peripherals, such as keyboard, mouse, monitor, and so on, from your computer.
  - 6 Remove any media card and optical disc from your computer, if applicable.

## Safety instructions

Use the following safety guidelines to protect your computer from potential damage and ensure your personal safety.

-  **WARNING:** Before working inside your computer, read the safety information that shipped with your computer. For more safety best practices, see the Regulatory Compliance home page at [dell.com/regulatory\\_compliance](http://dell.com/regulatory_compliance).
-  **WARNING:** Disconnect all power sources before opening the computer cover or panels. After you finish working inside the computer, replace all covers, panels, and screws before connecting to the power source.
-  **CAUTION:** To avoid damaging the computer, ensure that the work surface is flat and clean.
-  **CAUTION:** To avoid damaging the components and cards, handle them by their edges and avoid touching pins and contacts.
-  **CAUTION:** You should only perform troubleshooting and repairs as authorized or directed by the Dell technical assistance team. Damage due to servicing that is not authorized by Dell is not covered by your warranty. See the safety instructions that shipped with the product or at [dell.com/regulatory\\_compliance](http://dell.com/regulatory_compliance).
-  **CAUTION:** Before touching anything inside your computer, ground yourself by touching an unpainted metal surface, such as the metal at the back of the computer. While you work, periodically touch an unpainted metal surface to dissipate static electricity, which could harm internal components.
-  **CAUTION:** When you disconnect a cable, pull on its connector or on its pull tab, not on the cable itself. Some cables have connectors with locking tabs or thumb-screws that you must disengage before disconnecting the cable. When disconnecting cables, keep them evenly aligned to avoid bending any connector pins. When connecting cables, ensure that the ports and connectors are correctly oriented and aligned.
-  **CAUTION:** To disconnect a network cable, first unplug the cable from your computer and then unplug the cable from the network device.
-  **CAUTION:** Press and eject any installed card from the media-card reader.

## Recommended tools

The procedures in this document may require the following tools:

- Philips screwdriver
- Plastic scribe

# After working inside your computer

---



**CAUTION: Leaving stray or loose screws inside your computer may severely damage your computer.**

- 1 Replace all screws and ensure that no stray screws remain inside your computer.
- 2 Connect any external devices, peripherals, and cables you removed before working on your computer.
- 3 Replace any media cards, discs, and any other parts that you removed before working on your computer.
- 4 Connect your computer and all attached devices to their electrical outlets.
- 5 Turn on your computer.

# Removing the base cover

---



**WARNING:** Before working inside your computer, read the safety information that shipped with your computer and follow the steps in [Before working inside your computer](#). After working inside your computer, follow the instructions in [After working inside your computer](#). For more safety best practices, see the Regulatory Compliance home page at [dell.com/regulatory\\_compliance](http://dell.com/regulatory_compliance).

## Procedure

- 1 Close the display and turn the computer over.
- 2 Remove the screws that secure the base cover to the palmrest and keyboard assembly.

**3** Using a plastic scribe, pry the base cover from the palmrest and keyboard assembly.

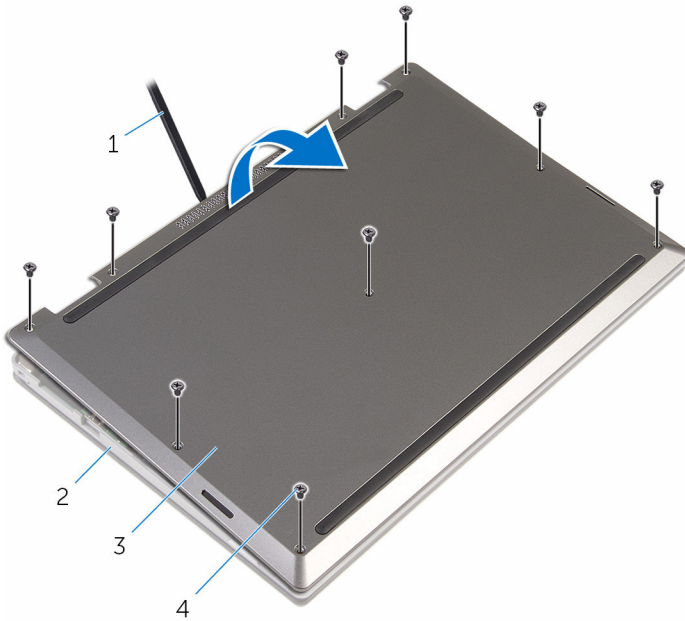

1 plastic scribe

2 palm rest and keyboard assembly

3 base cover

4 screws (9)

# Replacing the base cover

---



**WARNING:** Before working inside your computer, read the safety information that shipped with your computer and follow the steps in [Before working inside your computer](#). After working inside your computer, follow the instructions in [After working inside your computer](#). For more safety best practices, see the Regulatory Compliance home page at [dell.com/regulatory\\_compliance](http://dell.com/regulatory_compliance).

## Procedure

- 1 Slide the tabs on the base cover into the slots on the computer base and snap the base cover into place.
- 2 Replace the screws that secure the base cover to the computer base.

# Removing the battery

---



**WARNING:** Before working inside your computer, read the safety information that shipped with your computer and follow the steps in [Before working inside your computer](#). After working inside your computer, follow the instructions in [After working inside your computer](#). For more safety best practices, see the Regulatory Compliance home page at [dell.com/regulatory\\_compliance](http://dell.com/regulatory_compliance).

## Prerequisites

Remove the [base cover](#).

## Procedure

- 1 Remove the hard-drive cable from the routing guides on the battery.
- 2 Remove the screws that secure the battery to the palmrest and keyboard assembly.



- 3** Lift the battery off the palmrest and keyboard assembly.

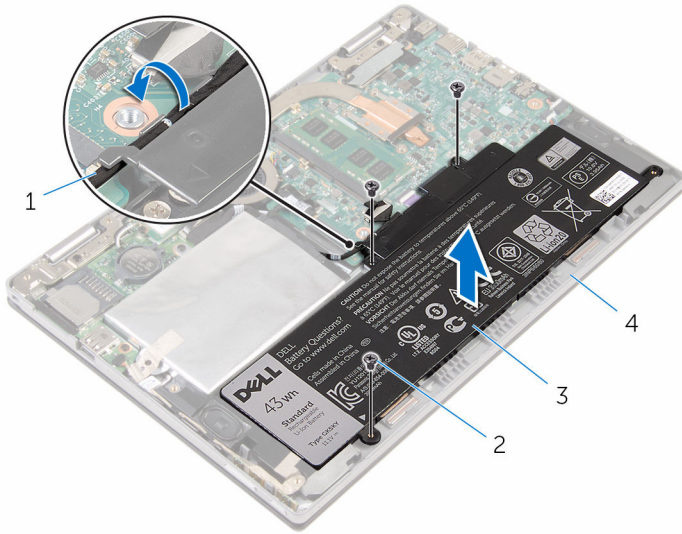

1 hard-drive cable

2 screws (3)

3 battery

4 palm rest and keyboard assembly

- 4** Press and hold the power button for 5 seconds, to ground the system board.

# Replacing the battery

---



**WARNING:** Before working inside your computer, read the safety information that shipped with your computer and follow the steps in [Before working inside your computer](#). After working inside your computer, follow the instructions in [After working inside your computer](#). For more safety best practices, see the Regulatory Compliance home page at [dell.com/regulatory\\_compliance](http://dell.com/regulatory_compliance).

## Procedure

- 1 Align the screw holes on the battery with the screw holes on the palm rest and keyboard assembly.
- 2 Route the hard-drive cable through the routing guides on the battery.
- 3 Replace the screws that secure the battery to the palm rest and keyboard assembly.

## Post-requisites

Replace the [base cover](#).

# Removing the memory module

---



**WARNING:** Before working inside your computer, read the safety information that shipped with your computer and follow the steps in [Before working inside your computer](#). After working inside your computer, follow the instructions in [After working inside your computer](#). For more safety best practices, see the Regulatory Compliance home page at [dell.com/regulatory\\_compliance](http://dell.com/regulatory_compliance).

## Prerequisites

- 1 Remove the [base cover](#).
- 2 Remove the [battery](#).

## Procedure

- 1 Use your fingertips to carefully spread apart the securing-clips on each end of the memory-module slot until the memory module pops up.

2 Remove the memory module from the memory-module slot.

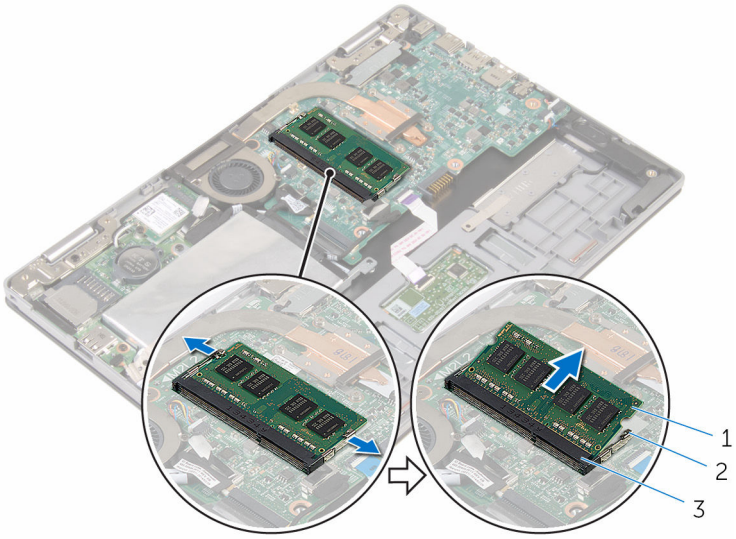

- 1 memory module
- 3 memory-module slot

2 securing clips (2)

# Replacing the memory module

---



**WARNING:** Before working inside your computer, read the safety information that shipped with your computer and follow the steps in [Before working inside your computer](#). After working inside your computer, follow the instructions in [After working inside your computer](#). For more safety best practices, see the Regulatory Compliance home page at [dell.com/regulatory\\_compliance](http://dell.com/regulatory_compliance).

## Procedure

- 1 Align the notch on the memory module with the tab on the memory-module slot.

- Slide the memory module firmly into the slot at an angle and press the memory module down until it clicks into place.

 **NOTE:** If you do not hear the click, remove the memory module and reinstall it.

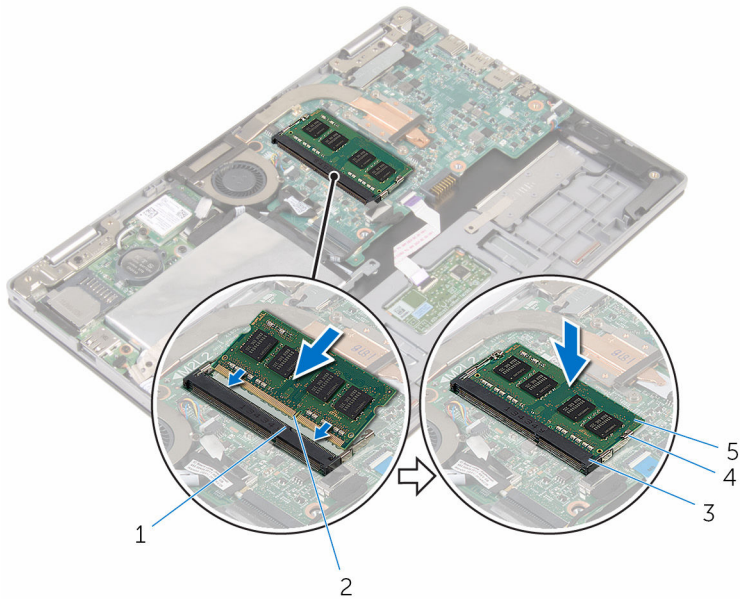



- |   |                    |   |                    |
|---|--------------------|---|--------------------|
| 1 | tab                | 2 | notch              |
| 3 | memory-module slot | 4 | securing clips (2) |
| 5 | memory module      |   |                    |

## Post-requisites

- Replace the [battery](#).
- Replace the [base cover](#).

# Removing the hard drive

---

-  **WARNING:** Before working inside your computer, read the safety information that shipped with your computer and follow the steps in [Before working inside your computer](#). After working inside your computer, follow the instructions in [After working inside your computer](#). For more safety best practices, see the Regulatory Compliance home page at [dell.com/regulatory\\_compliance](http://dell.com/regulatory_compliance).
-  **CAUTION:** Hard drives are fragile. Exercise care when handling the hard drive.
-  **CAUTION:** To avoid data loss, do not remove the hard drive while the computer is in sleep or on state.

## Prerequisites

- 1 Remove the [base cover](#).
- 2 Remove the [battery](#).

## Procedure

- 1 Using the pull tab, disconnect the hard-drive cable from the system board.
- 2 Peel off the tape that secures the hard-drive assembly to the palm rest and keyboard assembly.
- 3 Remove the screws that secure the hard-drive assembly to the palm rest and keyboard assembly.

- 4** Lift the hard-drive assembly along with its cable off the palm rest and keyboard assembly.

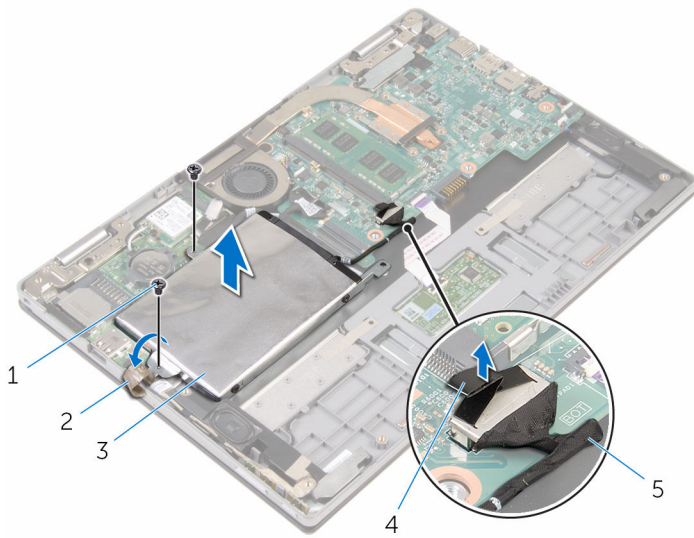

1 screws (2)

2 tape

3 hard-drive assembly

4 pull tab

5 hard-drive cable

- 5** Disconnect the interposer from the hard drive.  
**6** Remove the screws that secure the hard-drive bracket to the hard drive.



7 Lift the hard-drive bracket from the hard drive.

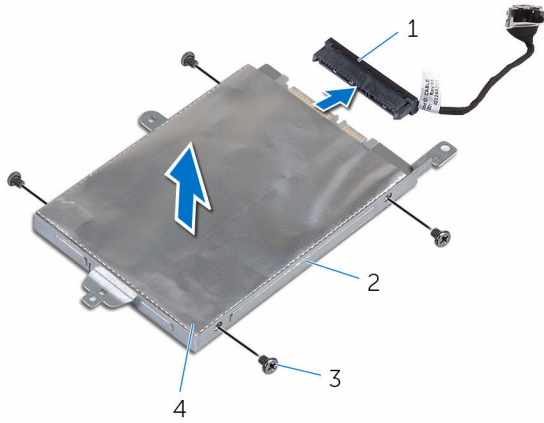

1 interposer

2 hard-drive bracket

3 screws (4)

4 hard drive

# Replacing the hard drive

---

 **WARNING:** Before working inside your computer, read the safety information that shipped with your computer and follow the steps in [Before working inside your computer](#). After working inside your computer, follow the instructions in [After working inside your computer](#). For more safety best practices, see the Regulatory Compliance home page at [dell.com/regulatory\\_compliance](http://dell.com/regulatory_compliance).

 **CAUTION:** Hard drives are fragile. Exercise care when handling the hard drive.

## Procedure



- 1 Align the screw holes on the hard drive with the screw holes on the hard-drive bracket.
- 2 Replace the screws that secure the hard-drive bracket to the hard drive.
- 3 Connect the interposer to the hard drive.
- 4 Align the screw holes on the hard-drive assembly with the screw holes on the palm rest and keyboard assembly.
- 5 Replace the screws that secure the hard-drive assembly to the palm rest and keyboard assembly.
- 6 Adhere the tape that secures the hard-drive assembly to the palm rest and keyboard assembly.
- 7 Connect the hard-drive cable to the system board.

## Post-requisites

- 1 Replace the [battery](#).
- 2 Replace the [base cover](#).

# Removing the coin-cell battery

---

-  **WARNING:** Before working inside your computer, read the safety information that shipped with your computer and follow the steps in [Before working inside your computer](#). After working inside your computer, follow the instructions in [After working inside your computer](#). For more safety best practices, see the Regulatory Compliance home page at [dell.com/regulatory\\_compliance](http://dell.com/regulatory_compliance).
-  **CAUTION:** Removing the coin-cell battery resets the BIOS setup program's settings to default. It is recommended that you note the BIOS setup program's settings before removing the coin-cell battery.

## Prerequisites

- 1 Remove the [base cover](#).
- 2 Remove the [battery](#).

## Procedure

Using a plastic scribe, gently pry the coin-cell battery out of the battery socket on the I/O board.

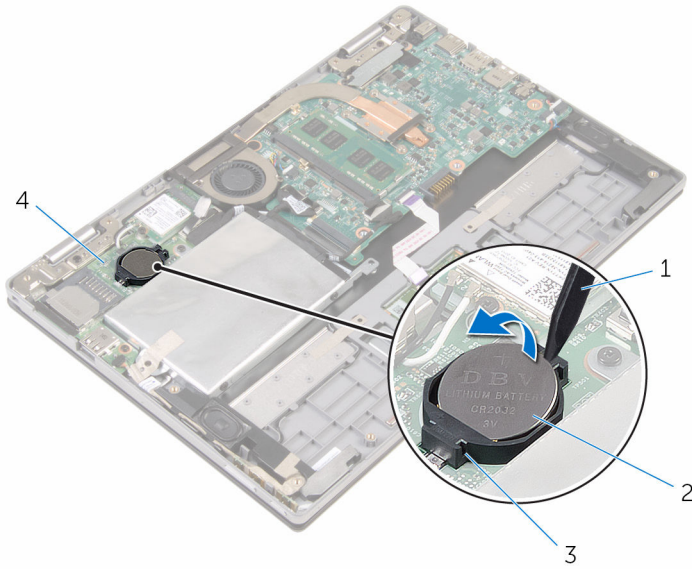

1 plastic scribe  
3 battery socket

2 coin-cell battery  
4 I/O board

# Replacing the coin-cell battery

---



**WARNING:** Before working inside your computer, read the safety information that shipped with your computer and follow the steps in [Before working inside your computer](#). After working inside your computer, follow the instructions in [After working inside your computer](#). For more safety best practices, see the Regulatory Compliance home page at [dell.com/regulatory\\_compliance](http://dell.com/regulatory_compliance).

## Procedure

With the positive-side facing up, snap the coin-cell battery into the battery socket on the I/O board.

## Post-requisites

- 1 Replace the [battery](#).
- 2 Replace the [base cover](#).

# Removing the wireless card

---



**WARNING:** Before working inside your computer, read the safety information that shipped with your computer and follow the steps in [Before working inside your computer](#). After working inside your computer, follow the instructions in [After working inside your computer](#). For more safety best practices, see the Regulatory Compliance home page at [dell.com/regulatory\\_compliance](http://dell.com/regulatory_compliance).

## Prerequisites

- 1 Remove the [base cover](#).
- 2 Remove the [battery](#).

## Procedure

- 1 Disconnect the antenna cables from the wireless card.
- 2 Remove the screw that secures the wireless card to the I/O board.

**3** Slide the wireless card from the wireless-card slot on the I/O board.

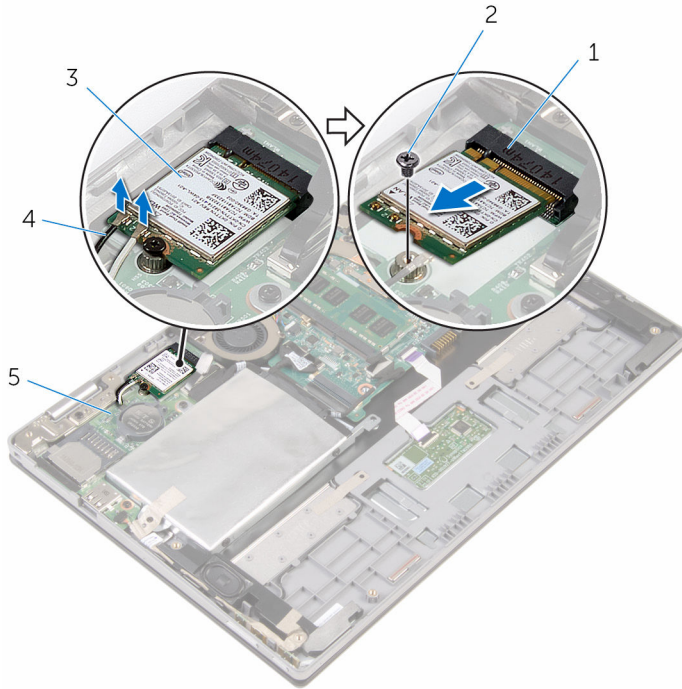

1 wireless-card slot

2 screw

3 wireless card

4 antenna cables (2)

5 I/O board

# Replacing the wireless card

---

 **WARNING:** Before working inside your computer, read the safety information that shipped with your computer and follow the steps in [Before working inside your computer](#). After working inside your computer, follow the instructions in [After working inside your computer](#). For more safety best practices, see the Regulatory Compliance home page at [dell.com/regulatory\\_compliance](http://dell.com/regulatory_compliance).

## Procedure

 **CAUTION:** To avoid damage to the wireless card, do not place any cables under it.

- 1 Align the notch on the wireless card with the tab on the wireless-card slot on the I/O board.
- 2 Insert the wireless card at an angle into the wireless-card slot.
- 3 Align the screw hole on the wireless card with the screw hole on the I/O board.
- 4 Replace the screw that secures the wireless card to the I/O board.



- 5 Connect the antenna cables to the wireless card.

The following table provides the antenna-cable color scheme for the wireless card supported by your computer.

Connectors on the wireless card	Antenna-cable color
Main (white triangle)	white
Auxiliary (black triangle)	black

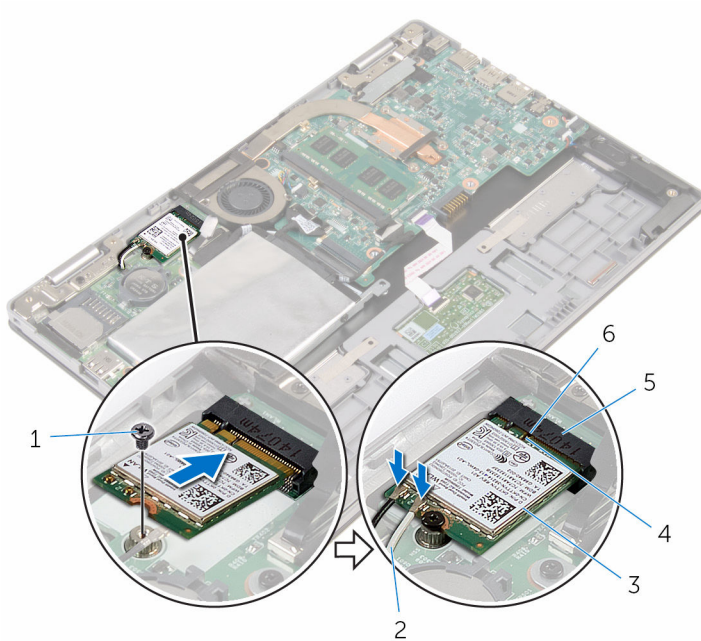

- |   |                    |   |                    |
|---|--------------------|---|--------------------|
| 1 | screw              | 2 | antenna cables (2) |
| 3 | wireless card      | 4 | notch              |
| 5 | wireless-card slot | 6 | tab                |

## Post-requisites

- 1 Replace the [battery](#).
- 2 Replace the [base cover](#).

# Removing the power and volume-buttons board

---



**WARNING:** Before working inside your computer, read the safety information that shipped with your computer and follow the steps in [Before working inside your computer](#). After working inside your computer, follow the instructions in [After working inside your computer](#). For more safety best practices, see the Regulatory Compliance home page at [dell.com/regulatory\\_compliance](http://dell.com/regulatory_compliance).

## Prerequisites

- 1 Remove the [base cover](#).
- 2 Remove the [battery](#).

## Procedure

- 1 Peel the tape that secures the power and volume buttons-board cable to the hard-drive assembly.
- 2 Disconnect the power and volume-buttons board cable from the I/O board.
- 3 Remove the power and volume-buttons board cable from the routing guides on the speaker.
- 4 Peel the tape that secures the power and volume-buttons board to the speaker.

- 5 Lift the power and volume-buttons board along with its cable, off the palm rest and keyboard assembly.

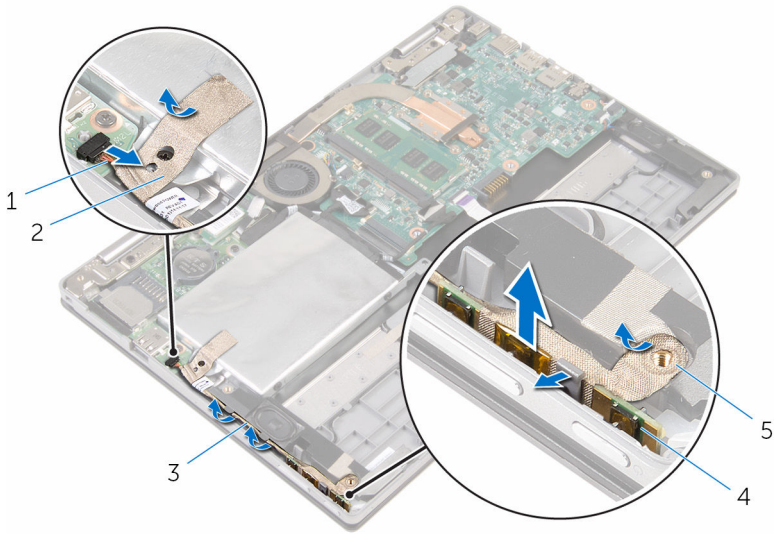

- |   |                                      |   |                                |
|---|--------------------------------------|---|--------------------------------|
| 1 | power and volume-buttons board cable | 2 | tape                           |
| 3 | routing guides                       | 4 | power and volume-buttons board |
| 5 | tape                                 |   |                                |

# Replacing the power and volume-buttons board

---



**WARNING:** Before working inside your computer, read the safety information that shipped with your computer and follow the steps in [Before working inside your computer](#). After working inside your computer, follow the instructions in [After working inside your computer](#). For more safety best practices, see the Regulatory Compliance home page at [dell.com/regulatory\\_compliance](http://dell.com/regulatory_compliance).

## Procedure

- 1 Place the power and volume-buttons board into the slot on the palm rest and keyboard assembly.
- 2 Adhere the tape that secures the power and volume-buttons board to the speaker.
- 3 Route the power and volume-buttons board cable through the routing guides on the speaker.
- 4 Connect the power and volume-buttons board cable to the I/O board.
- 5 Adhere the tape that secures the power and volume-buttons board cable to the hard-drive assembly.

## Post-requisites

- 1 Replace the [battery](#).
- 2 Replace the [base cover](#).

# Removing the speakers

---



**WARNING:** Before working inside your computer, read the safety information that shipped with your computer and follow the steps in [Before working inside your computer](#). After working inside your computer, follow the instructions in [After working inside your computer](#). For more safety best practices, see the Regulatory Compliance home page at [dell.com/regulatory\\_compliance](http://dell.com/regulatory_compliance).

## Prerequisites

- 1 Remove the [base cover](#).
- 2 Remove the [battery](#).
- 3 Follow the procedure from step 1 to step 3 in "[Removing the hard drive](#)".
- 4 Remove the [power and volume-buttons board](#).

# Procedure

- 1 Lift the connector latch and disconnect the touch-pad cable from the connector on the touch pad.

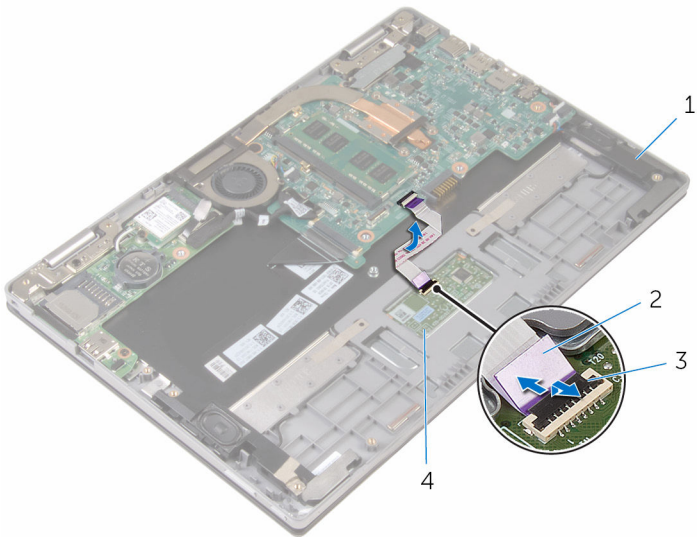

1 speakers (2)

2 touch-pad cable

3 connector latch

4 touch pad

- 2 Peel the Mylar from the palm rest and keyboard assembly to access the speaker cable.

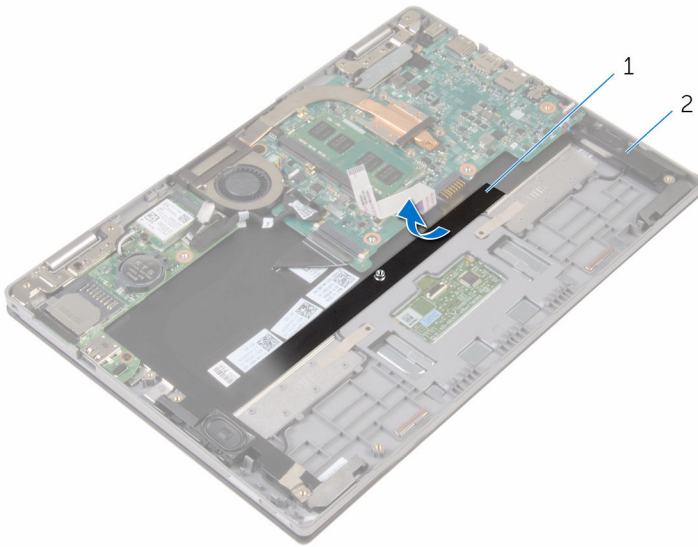

1 Mylar

2 speakers (2)

- 3 Disconnect the speaker cable from the system board.
- 4 Peel off the adhesive tapes that secure the speaker cable to the palm rest and keyboard assembly.
- 5 Remove the speaker cable from the routing guides on the palm rest and keyboard assembly.

- 6 Release the speakers from the alignment posts and lift the speakers along with its cable off the palm rest and keyboard assembly.

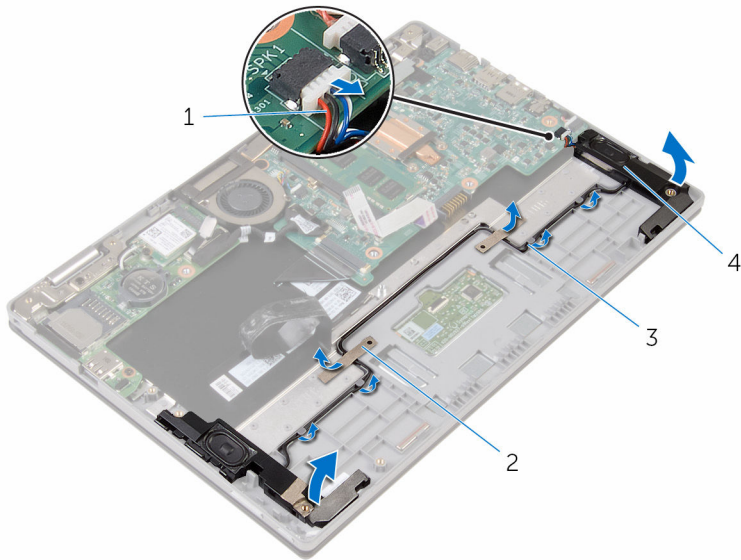

- 1 speaker cable
- 3 routing guides

- 2 adhesive tapes (2)
- 4 speakers (2)



# Replacing the speakers

---



**WARNING:** Before working inside your computer, read the safety information that shipped with your computer and follow the steps in [Before working inside your computer](#). After working inside your computer, follow the instructions in [After working inside your computer](#). For more safety best practices, see the Regulatory Compliance home page at [dell.com/regulatory\\_compliance](http://dell.com/regulatory_compliance).

## Procedure

- 1 Using the alignment posts on the palm rest and keyboard assembly, place the speakers on the palm rest and keyboard assembly.
- 2 Route the speaker cable through the routing guides on the palm rest and keyboard assembly.
- 3 Adhere the tapes that secure the speaker cable to the palm rest and keyboard assembly.
- 4 Connect the speaker cable to the system board.
- 5 Adhere the Mylar to secure the speaker cable to the palm rest and keyboard assembly.
- 6 Slide the touch-pad cable into the connector on the touch pad and press down the connector latch to secure the cable.

## Post-requisites

- 1 Replace the [power and volume-buttons board](#).
- 2 Follow the procedure from step 4 to step 6 in "[Replacing the hard drive](#)".
- 3 Replace the [battery](#).
- 4 Replace the [base cover](#).

# Removing the touch pad

---



**WARNING:** Before working inside your computer, read the safety information that shipped with your computer and follow the steps in [Before working inside your computer](#). After working inside your computer, follow the instructions in [After working inside your computer](#). For more safety best practices, see the Regulatory Compliance home page at [dell.com/regulatory\\_compliance](http://dell.com/regulatory_compliance).

## Prerequisites

- 1 Remove the [base cover](#).
- 2 Remove the [battery](#).

## Procedure

- 1 Lift the connector latch and disconnect the touch-pad cable from the touch pad.

2 Peel the tapes to access the screws on the touch pad.

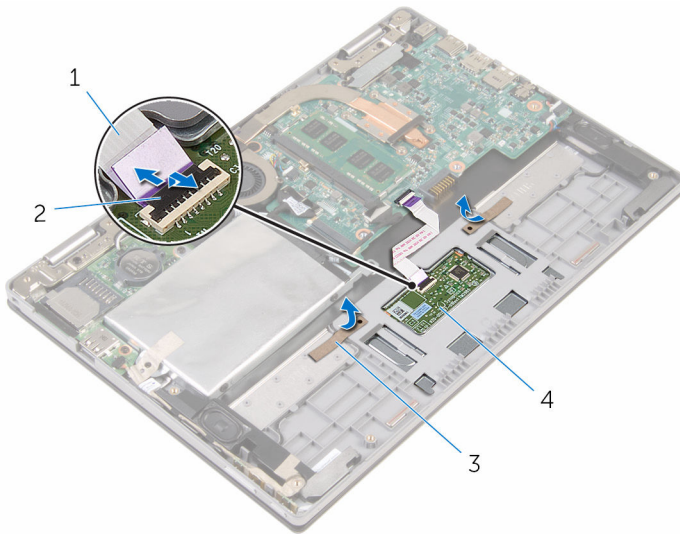

1 touch-pad cable

2 connector latch

3 tapes (2)

4 touch pad

- 3 Remove the screws that secure the touch pad to the palm rest and keyboard assembly.

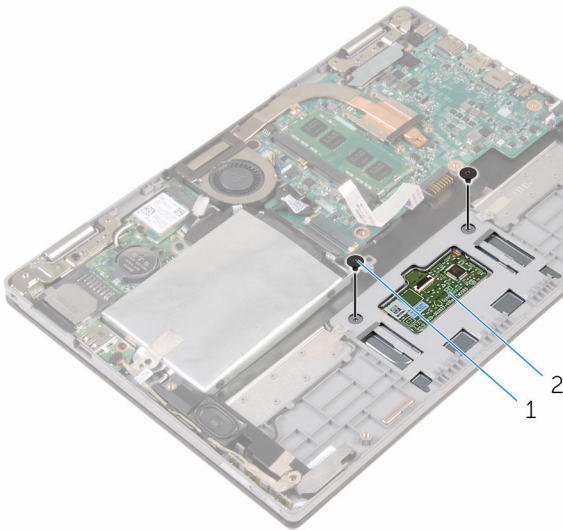

1 screws (2)

2 touch pad

- 4 Raise the palmrest and keyboard assembly to release the touch pad from the slots on the palm rest and keyboard assembly.
- 5 Slide the touch pad away from the computer to release it from the slots on the palm rest and keyboard assembly.

- 6 Remove the touch pad from the keyboard and palm rest and keyboard assembly.

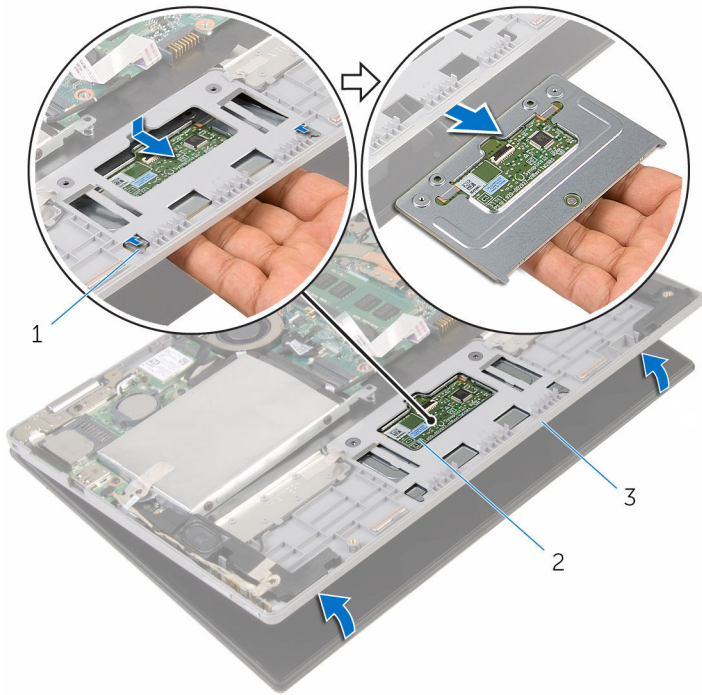

1 tabs (2)

2 touch pad

3 palm rest and keyboard  
assembly

# Replacing the touch pad

---



**WARNING:** Before working inside your computer, read the safety information that shipped with your computer and follow the steps in [Before working inside your computer](#). After working inside your computer, follow the instructions in [After working inside your computer](#). For more safety best practices, see the Regulatory Compliance home page at [dell.com/regulatory\\_compliance](http://dell.com/regulatory_compliance).

## Procedure



- 1 Align the tabs on the touch pad into the slots on the palm rest and keyboard assembly.
- 2 Align the screw holes on the touch pad with the screw holes on the palm rest and keyboard assembly.
- 3 Replace the screws that secure the touch pad to the palm rest and keyboard assembly.
- 4 Adhere the tapes to secure the screws to the touch pad.
- 5 Slide the touch-pad cable into the touch pad connector and press down the latch to secure the cable.

## Post-requisites

- 1 Replace the [battery](#).
- 2 Replace the [base cover](#).

# Removing the processor fan and heat-sink assembly

---

-  **WARNING:** Before working inside your computer, read the safety information that shipped with your computer and follow the steps in [Before working inside your computer](#). After working inside your computer, follow the instructions in [After working inside your computer](#). For more safety best practices, see the Regulatory Compliance home page at [dell.com/regulatory\\_compliance](http://dell.com/regulatory_compliance).
-  **WARNING:** The heat sink may become hot during normal operation. Allow sufficient time for the heat sink to cool before you touch it.
-  **CAUTION:** For maximum cooling of the processor, do not touch the heat transfer areas on the heat sink. The oils in your skin can reduce the heat transfer capability of the thermal grease.

## Prerequisites

- 1 Remove the [base cover](#).
- 2 Remove the [battery](#).

## Procedure

-  **NOTE:** The appearance of the heat sink and the number of screws will vary if you purchased your computer with integrated graphics card.
- 1 Disconnect the fan cable from the system board.
  - 2 In sequential order (indicated on the heat sink), loosen the captive screws that secure the processor fan and heat-sink assembly to the system board.

**3** Lift the processor fan and heat-sink assembly off the system board.

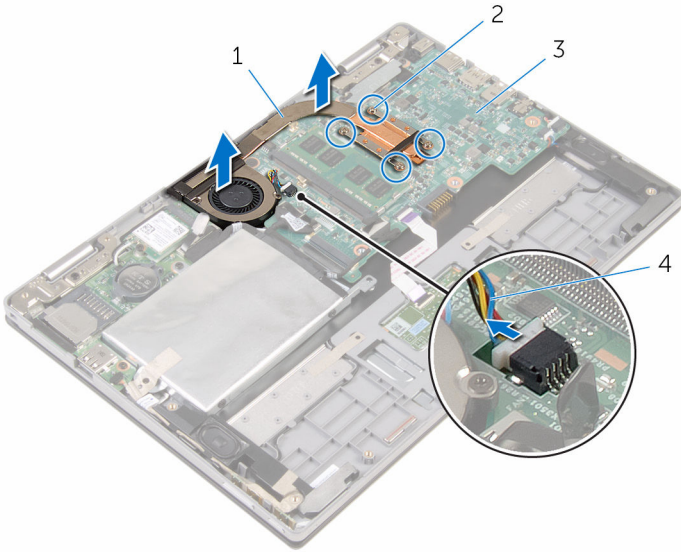

1 processor fan and heat-sink assembly

2 captive screws (4)

3 system board

4 fan cable



# Replacing the processor fan and heat-sink assembly

---



**WARNING:** Before working inside your computer, read the safety information that shipped with your computer and follow the steps in [Before working inside your computer](#). After working inside your computer, follow the instructions in [After working inside your computer](#). For more safety best practices, see the Regulatory Compliance home page at [dell.com/regulatory\\_compliance](http://dell.com/regulatory_compliance).

## Procedure

- 1 Align the screw holes on the processor fan and heat-sink assembly with the screw holes on the system board and place the processor fan and heat sink assembly on it.
- 2 In sequential order, (indicated on the heat sink), tighten the captive screws that secure the processor fan and heat-sink assembly to the system board.
- 3 Connect the fan cable to the system board.

## Post-requisites

- 1 Replace the [battery](#).
- 2 Replace the [base cover](#).

# Removing the I/O board

---



**WARNING:** Before working inside your computer, read the safety information that shipped with your computer and follow the steps in [Before working inside your computer](#). After working inside your computer, follow the instructions in [After working inside your computer](#). For more safety best practices, see the Regulatory Compliance home page at [dell.com/regulatory\\_compliance](http://dell.com/regulatory_compliance).

## Prerequisites

- 1 Remove the [base cover](#).
- 2 Remove the [battery](#).
- 3 Remove the [hard drive](#).
- 4 Remove the [wireless card](#).
- 5 Remove the [coin-cell battery](#).

## Procedure

- 1 Disconnect the I/O-board cable from the I/O board.
- 2 Disconnect the power and volume-buttons board cable from the I/O board.
- 3 Remove the screw that secures the I/O board to the palm rest and keyboard assembly.

- 4 Lift the I/O board off the palm rest and keyboard assembly.

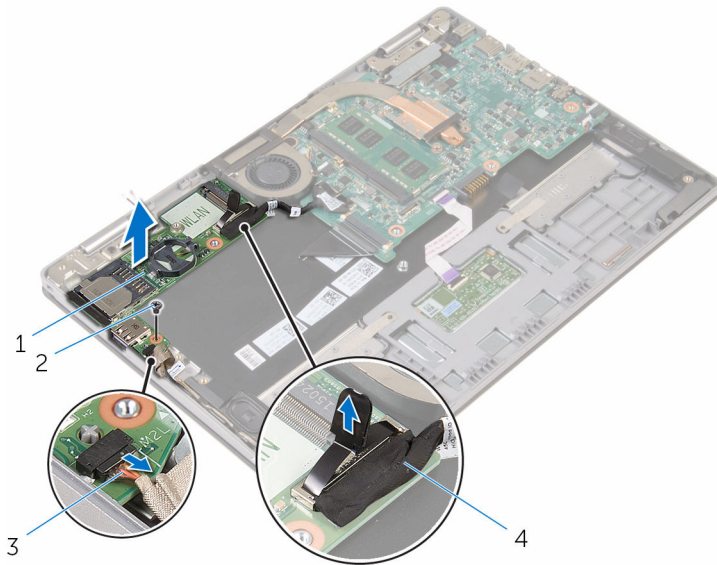

1 I/O board

2 screw

3 power and volume-buttons  
board cable

4 I/O-board cable

# Replacing the I/O board

---



**WARNING:** Before working inside your computer, read the safety information that shipped with your computer and follow the steps in [Before working inside your computer](#). After working inside your computer, follow the instructions in [After working inside your computer](#). For more safety best practices, see the Regulatory Compliance home page at [dell.com/regulatory\\_compliance](http://dell.com/regulatory_compliance).

## Procedure

- 1 Using the alignment posts, place the I/O board on the palm rest and keyboard assembly.
- 2 Align the screw hole on the I/O board with the screw hole on the palm rest and keyboard assembly.
- 3 Replace the screw that secures the I/O board to the palm rest and keyboard assembly.
- 4 Connect the power and volume-buttons board cable to the I/O board.
- 5 Connect the I/O-board cable to the I/O board.

## Post-requisites

- 1 Replace the [coin-cell battery](#).
- 2 Replace the [wireless card](#).
- 3 Replace the [hard drive](#).
- 4 Replace the [battery](#).
- 5 Replace the [base cover](#).

# Removing the system board

---



**WARNING:** Before working inside your computer, read the safety information that shipped with your computer and follow the steps in [Before working inside your computer](#). After working inside your computer, follow the instructions in [After working inside your computer](#). For more safety best practices, see the Regulatory Compliance home page at [dell.com/regulatory\\_compliance](http://dell.com/regulatory_compliance).



**NOTE:** Your computer's Service Tag is stored in the system board. You must enter the Service Tag in the BIOS setup program after you replace the system board.



**NOTE:** Replacing the system board removes any changes you have made to the BIOS using the BIOS setup program. You must make the desired changes again after you replace the system board.



**NOTE:** Before disconnecting the cables from the system board, note the location of the connectors so that you can reconnect them correctly after you replace the system board.

## Prerequisites

- 1 Remove the [base cover](#).
- 2 Remove the [battery](#).
- 3 Remove the [memory module](#).
- 4 Remove the [processor fan and heat-sink assembly](#).

## Procedure

- 1 Remove the screws that secure the display-cable bracket to the system board and lift the display-cable bracket off the system board.
- 2 Peel off the adhesive tape on the Windows-button board connector to access the Windows-button board cable.
- 3 Lift the connector latch and disconnect the Windows-button board cable from the system board.

**4** Using the pull tab disconnect the display cable from the system board.

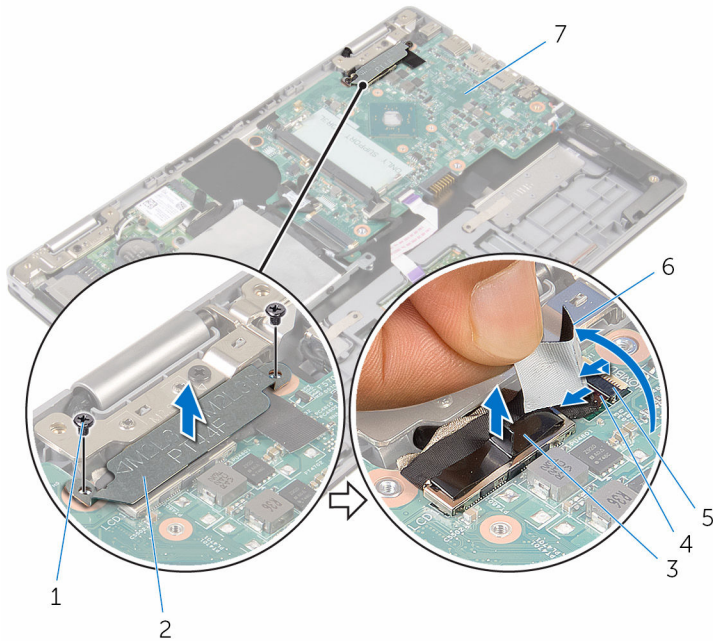

1 screws (2)

3 display cable

5 latch

7 system board

2 display-cable bracket

4 Windows-button board cable

6 adhesive tape

**5** Using the pull tab disconnect the I/O-board cable and the hard-drive cable from the system board.

**6** Release the connector latches and disconnect the keyboard cable from the system board.

**7** Lift the connector latch and disconnect the touch-pad cable from the system board.

- 8** Disconnect the speaker cable and the power-adapter port cable from the system board.

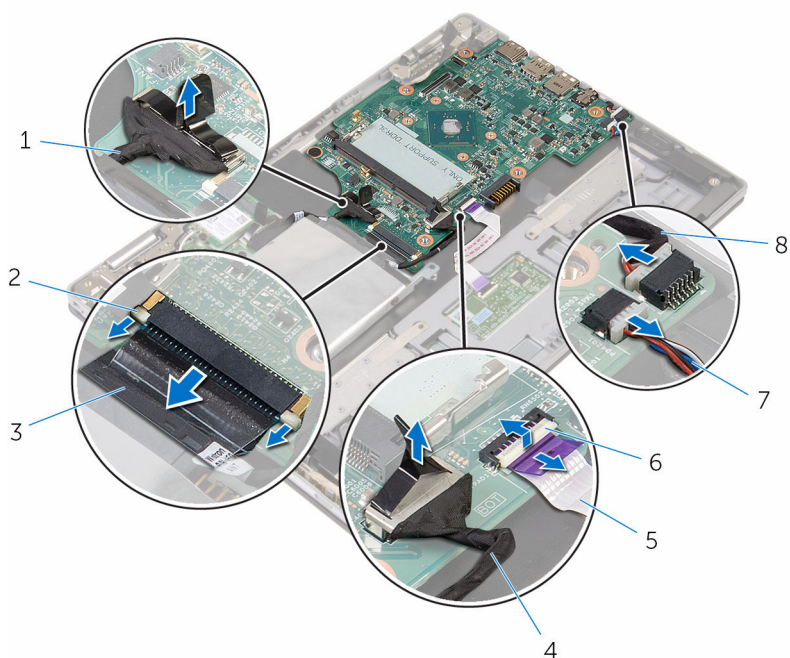

- |   |                 |   |                          |
|---|-----------------|---|--------------------------|
| 1 | I/O-board cable | 2 | latch                    |
| 3 | keyboard cable  | 4 | hard-drive cable         |
| 5 | touch-pad cable | 6 | latch                    |
| 7 | speaker cable   | 8 | power-adapter port cable |

- 9** Remove the screw that secures the system board to the palm rest and keyboard assembly.

10 Lift the system board off the palm rest and keyboard assembly.

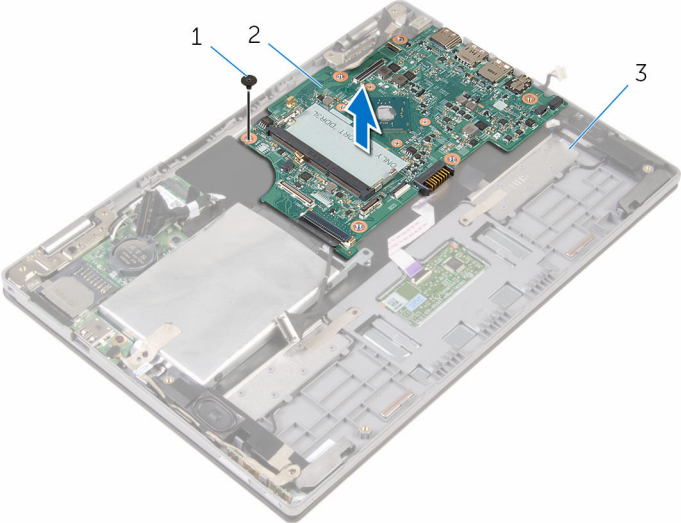

1 screw

2 system board

3 palm rest and keyboard assembly



# Replacing the system board

---



**WARNING:** Before working inside your computer, read the safety information that shipped with your computer and follow the steps in [Before working inside your computer](#). After working inside your computer, follow the instructions in [After working inside your computer](#). For more safety best practices, see the Regulatory Compliance home page at [dell.com/regulatory\\_compliance](http://dell.com/regulatory_compliance).



**NOTE:** Your computer's Service Tag is stored in the system board. You must enter the Service Tag in the BIOS setup program after you replace the system board.



**NOTE:** Replacing the system board removes any changes you have made to the BIOS using the BIOS setup program. You must make the desired changes again after you replace the system board.

## Procedure

- 1 Align the screw holes on the system board with the screw holes on the palm rest and keyboard assembly.
- 2 Replace the screw that secures the system board to the palm rest and keyboard assembly.
- 3 Connect the power-adaptor port cable and the speaker cable to the system board.
- 4 Slide the touch-pad cable into the connector on the system board and press down the latch to secure the cable.
- 5 Slide the keyboard cable into the keyboard-cable connector and push the connector latches in to secure the cable.
- 6 Connect the I/O-board cable and the hard-drive cable to the system board.
- 7 Slide the Windows-button board cable into the connector on the system board and press down the latch to secure the cable.
- 8 Adhere the tape on the Windows-button board connector to secure the cable.
- 9 Connect the display cable to the system board.

- 10 Align the screw holes on the display-cable bracket with the screw holes on the system board.
- 11 Replace the screws that secure the display-cable bracket to the system board.

## Post-requisites

- 1 Replace the [processor fan and heat-sink assembly](#).
- 2 Replace the [memory module](#).
- 3 Replace the [battery](#).
- 4 Replace the [base cover](#).

## Entering the Service Tag in the BIOS setup program

- 1 Turn on the computer.
- 2 Press F2 when the DELL logo is displayed to enter the BIOS setup program.
- 3 Navigate to the **Main** tab and enter the Service Tag in the **Service Tag Input** field.

# Removing the power-adapter port

---

 **WARNING:** Before working inside your computer, read the safety information that shipped with your computer and follow the steps in [Before working inside your computer](#). After working inside your computer, follow the instructions in [After working inside your computer](#). For more safety best practices, see the Regulatory Compliance home page at [dell.com/regulatory\\_compliance](http://dell.com/regulatory_compliance).

## Prerequisites

- 1 Remove the [base cover](#).
- 2 Remove the [battery](#).
- 3 Remove the [memory module](#).
- 4 Remove the [processor fan and heat-sink assembly](#).
- 5 Remove the [system board](#).

## Procedure

- 1 Peel off the Mylar from the palm rest and keyboard assembly to access the power-adapter port cable.
- 2 Remove the screw that secures the power-adapter port to the palm rest and keyboard assembly.

**3** Lift the power-adapter port with its cable, off the palm rest and keyboard assembly.

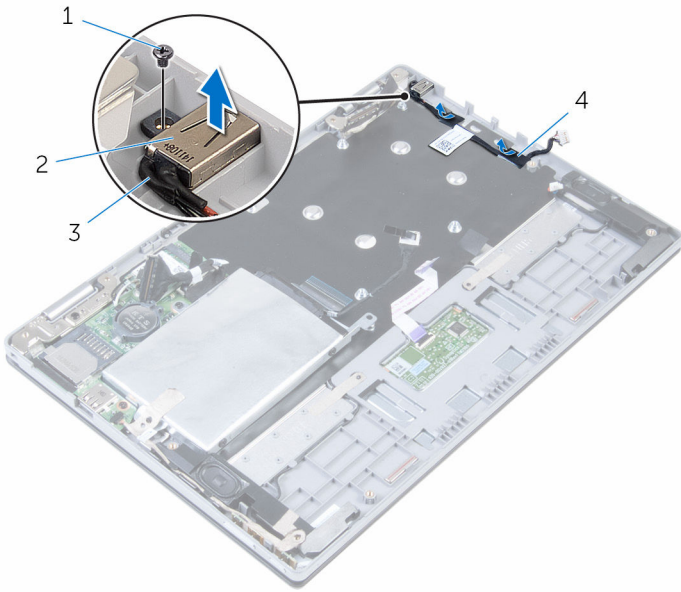

- |   |                          |   |                    |
|---|--------------------------|---|--------------------|
| 1 | screw                    | 2 | power-adapter port |
| 3 | power-adapter port cable | 4 | Mylar              |

# Replacing the power-adapter port

---



**WARNING:** Before working inside your computer, read the safety information that shipped with your computer and follow the steps in [Before working inside your computer](#). After working inside your computer, follow the instructions in [After working inside your computer](#). For more safety best practices, see the Regulatory Compliance home page at [dell.com/regulatory\\_compliance](http://dell.com/regulatory_compliance).

## Procedure

- 1 Place the power-adapter port into the slot on the palm rest and keyboard assembly.
- 2 Align the screw hole on the power-adapter port with the screw hole on the palm rest and keyboard assembly.
- 3 Replace the screw that secures the power-adapter port to the palm rest and keyboard assembly.
- 4 Connect the power-adapter port cable to the system board.
- 5 Adhere the Mylar to the palm rest and keyboard assembly.

## Post-requisites

- 1 Replace the [system board](#).
- 2 Replace the [processor fan and heat-sink assembly](#).
- 3 Replace the [memory module](#).
- 4 Replace the [battery](#).
- 5 Replace the [base cover](#).

# Removing the display assembly

---



**WARNING:** Before working inside your computer, read the safety information that shipped with your computer and follow the steps in [Before working inside your computer](#). After working inside your computer, follow the instructions in [After working inside your computer](#). For more safety best practices, see the Regulatory Compliance home page at [dell.com/regulatory\\_compliance](http://dell.com/regulatory_compliance).

## Prerequisites

- 1 Remove the [base cover](#).
- 2 Remove the [battery](#).

## Procedure

- 1 Disconnect the antenna cables from the wireless card.
- 2 Remove the screws that secure the display-cable bracket to the system board.
- 3 Lift the display-cable bracket off the system board.
- 4 Using the pull tab disconnect the display cable from the system board.
- 5 Peel off the adhesive tape to access the Windows button-board cable.

- 6 Lift the connector latch and disconnect the Windows button-board cable.

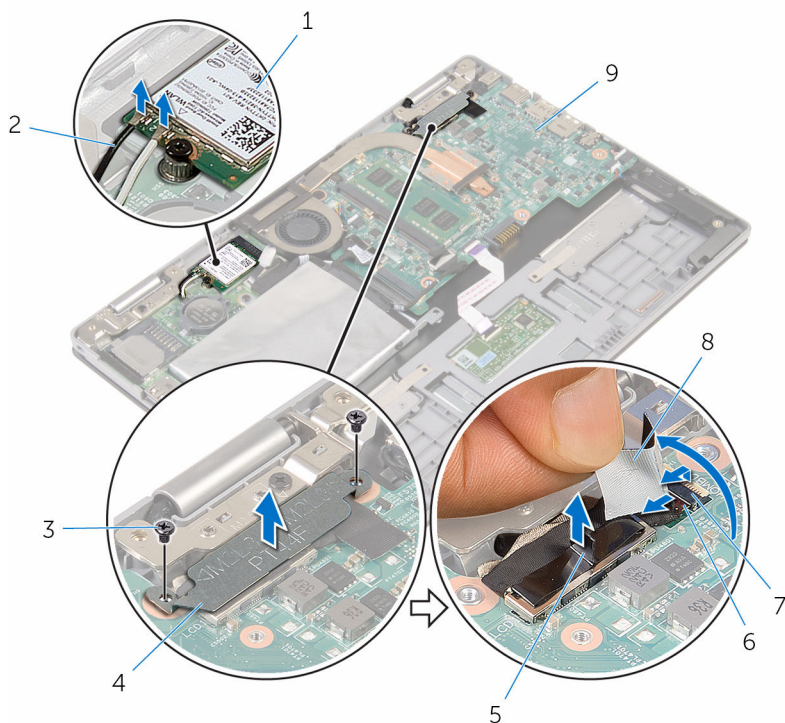

- |   |               |   |                            |
|---|---------------|---|----------------------------|
| 1 | wireless card | 2 | antenna cables (2)         |
| 3 | screws (2)    | 4 | display-cable bracket      |
| 5 | display cable | 6 | windows-button board cable |
| 7 | latch         | 8 | adhesive tape              |
| 9 | system board  |   |                            |

- 7 Turn the computer over and open the display as far as possible.

**⚠ CAUTION: Place the computer on a soft and clean surface to avoid scratching the display.**

- 8 Place the computer face down on a flat surface.  
9 Remove the screws that secure the display assembly to the palm rest and keyboard assembly.

10 Lift the display assembly off the palm rest and keyboard assembly.

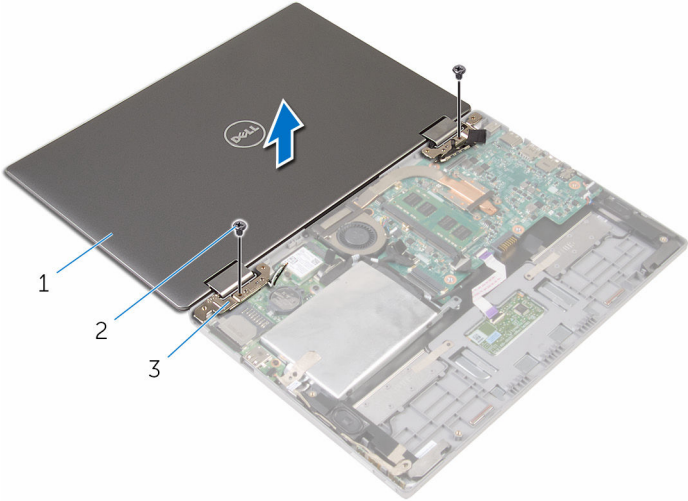

- 1 display assembly
- 3 display hinges (2)

- 2 screws (2)



# Replacing the display assembly

---

 **WARNING:** Before working inside your computer, read the safety information that shipped with your computer and follow the steps in [Before working inside your computer](#). After working inside your computer, follow the instructions in [After working inside your computer](#). For more safety best practices, see the Regulatory Compliance home page at [dell.com/regulatory\\_compliance](http://dell.com/regulatory_compliance).

## Procedure

 **CAUTION:** Place the computer on a soft and clean surface to avoid scratching the display.

- 1 Place the display assembly on the palm rest and keyboard assembly.
- 2 Align the screw holes on the display hinges with the screw holes on the palm rest and keyboard assembly.
- 3 Replace the screws that secure the display assembly to the palm rest and keyboard assembly.
- 4 Turn the computer over and close the display.
- 5 Turn the computer over.
- 6 Slide the Windows button-board connector into the connector latch on the system board and press down the latch to secure the cable.
- 7 Adhere the tape to the Windows button-board cable.
- 8 Connect the display cable to the system board.
- 9 Align the screw holes on the display-cable bracket with the screw holes on the system board.
- 10 Replace the screws that secure the display-cable bracket to the system board.
- 11 Connect the antenna cables to the wireless card.

# Post-requisites

- 1 Replace the [battery](#).
- 2 Replace the [base cover](#).

# Removing the palm rest and keyboard assembly

---

 **WARNING:** Before working inside your computer, read the safety information that shipped with your computer and follow the steps in [Before working inside your computer](#). After working inside your computer, follow the instructions in [After working inside your computer](#). For more safety best practices, see the Regulatory Compliance home page at [dell.com/regulatory\\_compliance](http://dell.com/regulatory_compliance).

## Prerequisites

- 1 Remove the [base cover](#).
- 2 Remove the [battery](#).
- 3 Follow the procedure from step 1 to step 3 in "[Removing the Hard Drive](#)".
- 4 Remove the [I/O board](#).
- 5 Remove the [speakers](#).
- 6 Remove the [touch pad](#).
- 7 Remove the [display assembly](#).
- 8 Remove the [power-adapter port](#).
- 9 Remove the [system board](#).

## Procedure

After performing the steps in prerequisites we are left with the palm rest and keyboard assembly.

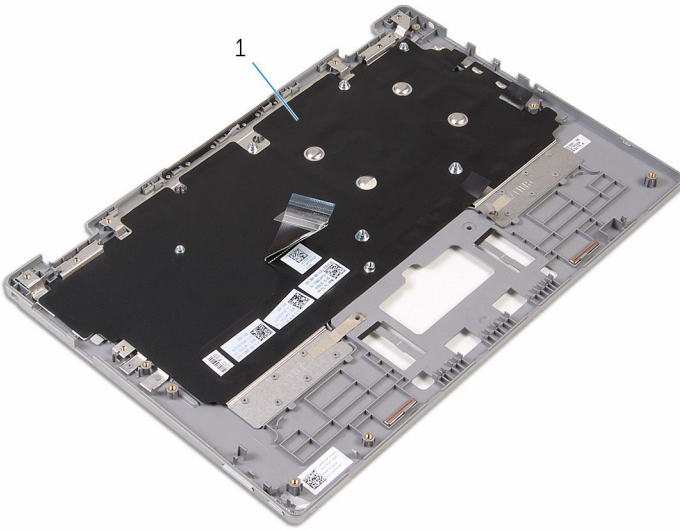

1 palm rest and keyboard assembly



1 palm rest and keyboard assembly

# Replacing the palm rest and keyboard assembly

---



**WARNING:** Before working inside your computer, read the safety information that shipped with your computer and follow the steps in [Before working inside your computer](#). After working inside your computer, follow the instructions in [After working inside your computer](#). For more safety best practices, see the Regulatory Compliance home page at [dell.com/regulatory\\_compliance](http://dell.com/regulatory_compliance).

## Procedure

Place the palm rest and keyboard assembly on a flat surface with the keyboard facing down.

## Post-requisites

- 1 Replace the [system board](#).
- 2 Replace the [power-adaptor port](#).
- 3 Replace the [display assembly](#).
- 4 Replace the [touch pad](#).
- 5 Replace the [speakers](#).
- 6 Replace the [I/O board](#).
- 7 Follow the procedure from step 4 to step 6 in "[Replacing the Hard Drive](#)".
- 8 Replace the [battery](#).
- 9 Replace the [base cover](#).

# Removing the display back-cover and antenna assembly

---



**WARNING:** Before working inside your computer, read the safety information that shipped with your computer and follow the steps in [Before working inside your computer](#). After working inside your computer, follow the instructions in [After working inside your computer](#). For more safety best practices, see the Regulatory Compliance home page at [dell.com/regulatory\\_compliance](http://dell.com/regulatory_compliance).

## Prerequisites

- 1 Remove the [base cover](#).
- 2 Remove the [battery](#).
- 3 Remove the [display assembly](#).

## Procedure

Using a plastic scribe, pry the display-panel assembly off the display back-cover and antenna assembly.

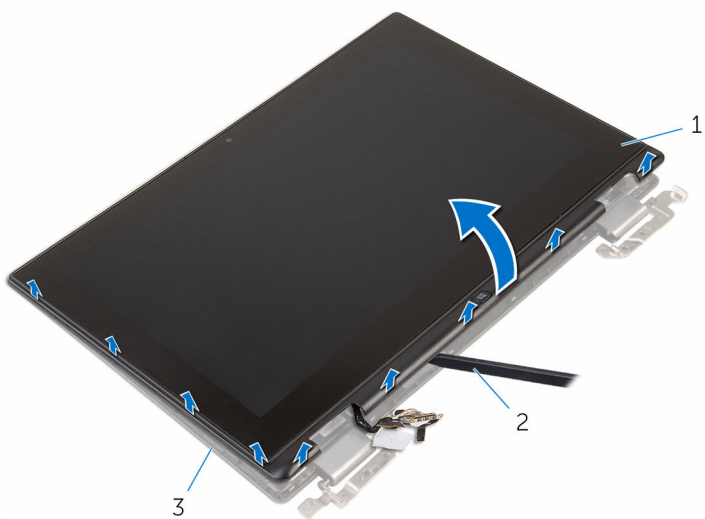

- 1 display-panel assembly
- 2 plastic scribe
- 3 display back-cover and antenna assembly

# Replacing the display back-cover and antenna assembly

---



**WARNING:** Before working inside your computer, read the safety information that shipped with your computer and follow the steps in [Before working inside your computer](#). After working inside your computer, follow the instructions in [After working inside your computer](#). For more safety best practices, see the Regulatory Compliance home page at [dell.com/regulatory\\_compliance](http://dell.com/regulatory_compliance).

## Procedure

Align the display-panel assembly with the display back-cover and antenna assembly and gently snap the display back-cover and antenna assembly into place.

## Post-requisites

- 1 Replace the [display assembly](#).
- 2 Replace the [battery](#).
- 3 Replace the [base cover](#).



# Removing the display hinges

---



**WARNING:** Before working inside your computer, read the safety information that shipped with your computer and follow the steps in [Before working inside your computer](#). After working inside your computer, follow the instructions in [After working inside your computer](#). For more safety best practices, see the Regulatory Compliance home page at [dell.com/regulatory\\_compliance](http://dell.com/regulatory_compliance).

## Prerequisites

- 1 Remove the [base cover](#).
- 2 Remove the [battery](#).
- 3 Remove the [display assembly](#).
- 4 Remove the [display back-cover and antenna assembly](#).

## Procedure

- 1 Remove the antenna cables from the routing guide on the hinge cover.
- 2 Remove the screws that secure the display hinges to the display back-cover and antenna assembly.

**3** Lift the display hinges off the display back-cover and antenna assembly.

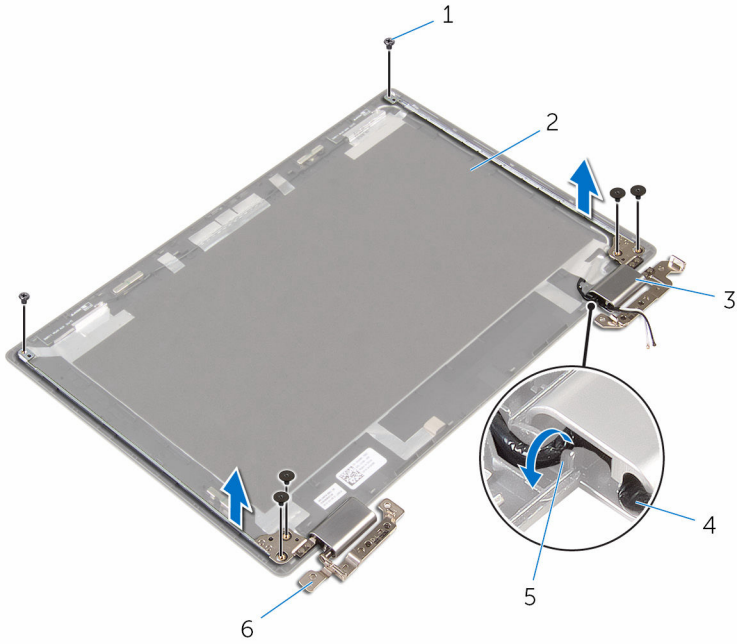

1 screws (6)

2 display back-cover and antenna assembly

3 hinge covers (2)

4 antenna cable

5 routing guides

6 hinges (2)

# Replacing the display hinges

---



**WARNING:** Before working inside your computer, read the safety information that shipped with your computer and follow the steps in [Before working inside your computer](#). After working inside your computer, follow the instructions in [After working inside your computer](#). For more safety best practices, see the Regulatory Compliance home page at [dell.com/regulatory\\_compliance](http://dell.com/regulatory_compliance).

## Procedure

- 1 Align the screw holes on the display hinges with the screw holes on the display back-cover and antenna assembly.
- 2 Replace the screws that secure the display hinges to the display back-cover and antenna assembly.
- 3 Route the antenna cables through the routing guide on the hinge cover and secure it in place.

## Post-requisites

- 1 Replace the [display back-cover and antenna assembly](#).
- 2 Replace the [display assembly](#).
- 3 Replace the [battery](#).
- 4 Replace the [base cover](#).

# Removing the camera

---



**WARNING:** Before working inside your computer, read the safety information that shipped with your computer and follow the steps in [Before working inside your computer](#). After working inside your computer, follow the instructions in [After working inside your computer](#). For more safety best practices, see the Regulatory Compliance home page at [dell.com/regulatory\\_compliance](http://dell.com/regulatory_compliance).

## Prerequisites

- 1 Remove the [base cover](#).
- 2 Remove the [battery](#).
- 3 Remove the [display assembly](#).
- 4 Remove the [display back-cover and antenna assembly](#).

## Procedure



**CAUTION:** Place the display-panel assembly on a soft and clean surface to avoid scratching the display.

- 1 Place the display-panel assembly face down on a flat surface.
- 2 Using a plastic scribe, pry the camera module off the display bezel.

- 3** Turn the camera over and disconnect the camera cable from the camera module.

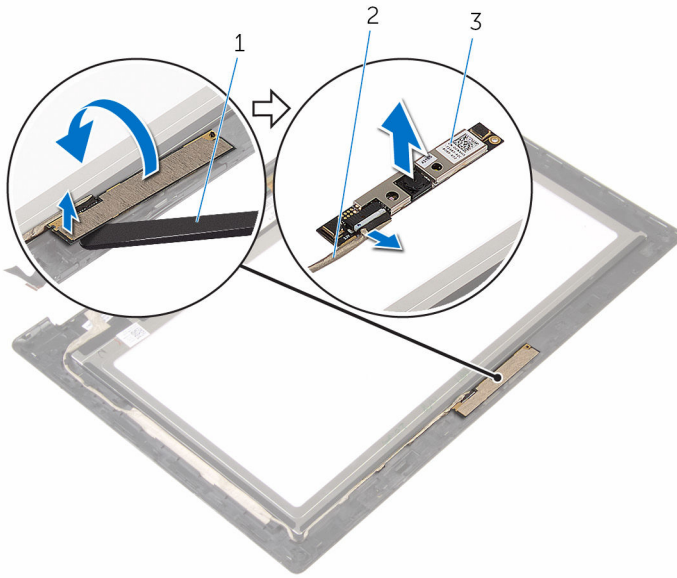

1 plastic scribe

2 camera cable

3 camera

# Replacing the camera

---



**WARNING:** Before working inside your computer, read the safety information that shipped with your computer and follow the steps in [Before working inside your computer](#). After working inside your computer, follow the instructions in [After working inside your computer](#). For more safety best practices, see the Regulatory Compliance home page at [dell.com/regulatory\\_compliance](http://dell.com/regulatory_compliance).

## Procedure

- 1 Connect the camera cable to the camera module.
- 2 Using the alignment post place the camera module on the display bezel and snap it into place.

## Post-requisites

- 1 Replace the [display back-cover and antenna assembly](#).
- 2 Replace the [display assembly](#).
- 3 Replace the [battery](#).
- 4 Replace the [base cover](#).

# Removing the Windows-button board

---

 **WARNING:** Before working inside your computer, read the safety information that shipped with your computer and follow the steps in [Before working inside your computer](#). After working inside your computer, follow the instructions in [After working inside your computer](#). For more safety best practices, see the Regulatory Compliance home page at [dell.com/regulatory\\_compliance](http://dell.com/regulatory_compliance).

## Prerequisites

- 1 Remove the [base cover](#).
- 2 Remove the [battery](#).
- 3 Remove the [display assembly](#).
- 4 Remove the [display back-cover and antenna assembly](#).

## Procedure

 **CAUTION:** Place the display-panel assembly on a soft and clean surface to avoid scratching the display.

- 1 Place the display-panel assembly face down on a flat surface.
- 2 Peel off the adhesive tape to access the Windows-button board cable.
- 3 Lift the connector latches and disconnect the Windows-button board cable and the touch-board cable from the Windows-button board.
- 4 Remove the screw that secures the Windows-button board to the display bezel.

- 5 Lift the Windows-button board off the display bezel.

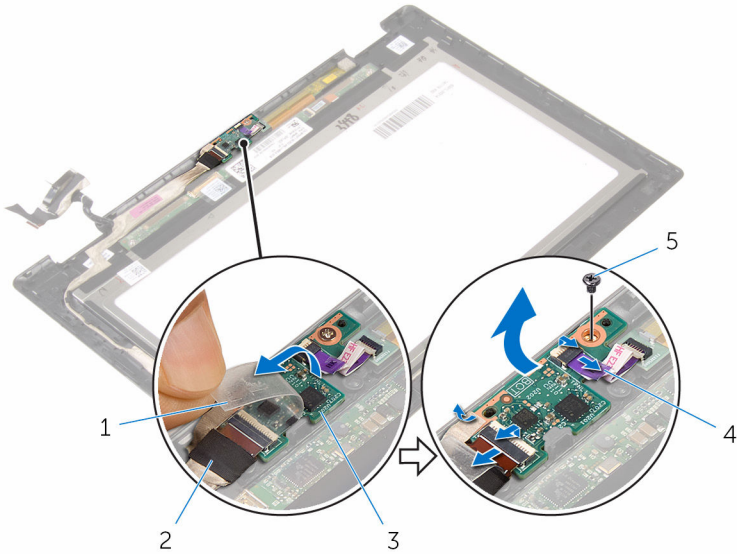

- |                        |                              |
|------------------------|------------------------------|
| 1 adhesive tape        | 2 Windows-button board cable |
| 3 Windows-button board | 4 touch-board cable          |
| 5 screw                |                              |



# Replacing the Windows-button board

---



**WARNING:** Before working inside your computer, read the safety information that shipped with your computer and follow the steps in [Before working inside your computer](#). After working inside your computer, follow the instructions in [After working inside your computer](#). For more safety best practices, see the Regulatory Compliance home page at [dell.com/regulatory\\_compliance](http://dell.com/regulatory_compliance).

## Procedure

- 1 Align the screw hole on the Windows-button board with the screw hole on the display bezel.
- 2 Replace the screw that secures the Windows-button board to the display bezel.
- 3 Slide the Windows-button board cable and the touch-board cable into the connectors on Windows-button board and press down the latches to secure the cables.
- 4 Adhere the adhesive tape to the connector on the Windows-button board to secure the cable.
- 5 Turn the display-panel assembly over.

## Post-requisites

- 1 Replace the [display back-cover and antenna assembly](#).
- 2 Replace the [display assembly](#).
- 3 Replace the [battery](#).
- 4 Replace the [base cover](#).

# Removing the display cable

---



**WARNING:** Before working inside your computer, read the safety information that shipped with your computer and follow the steps in [Before working inside your computer](#). After working inside your computer, follow the instructions in [After working inside your computer](#). For more safety best practices, see the Regulatory Compliance home page at [dell.com/regulatory\\_compliance](http://dell.com/regulatory_compliance).

## Prerequisites

- 1 Remove the [base cover](#).
- 2 Remove the [battery](#).
- 3 Remove the [display assembly](#).
- 4 Remove the [display back-cover and antenna assembly](#).
- 5 Remove the [camera](#).

## Procedure

- 1 Peel off the adhesive tape to access the Windows-button board cable.
- 2 Lift the connector latch and disconnect the Windows-button board cable from the Windows-button board.

- 3** Lift the connector latch and disconnect the display cable from the touch board.

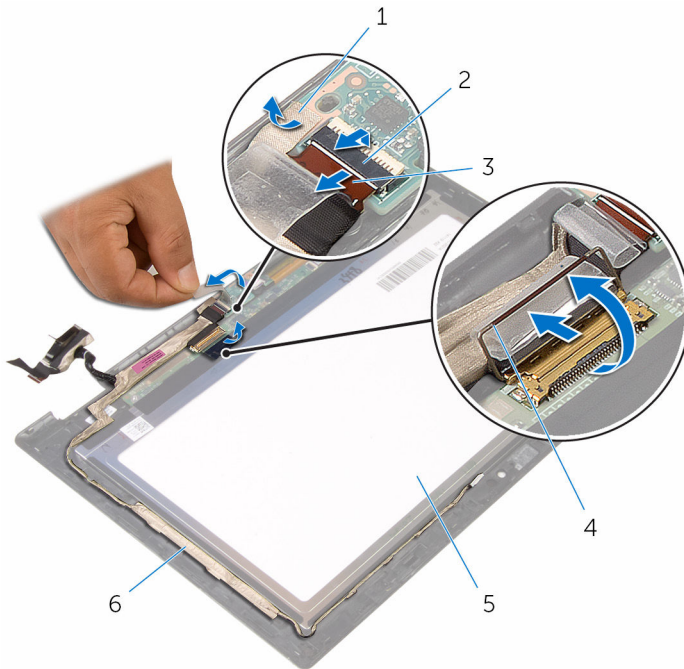

- |   |                            |   |  |
|---|----------------------------|---|--|
| 1 | adhesive tape              | 2 | connector latch for Windows-button board cable |
| 3 | Windows-button board cable | 4 | connector latch for display cable              |
| 5 | display panel              | 6 | display cable                                  |

- 4** Note the display cable routing and peel off the display cable from the routing guides on the display bezel.

5 Lift the display cable off the display bezel.

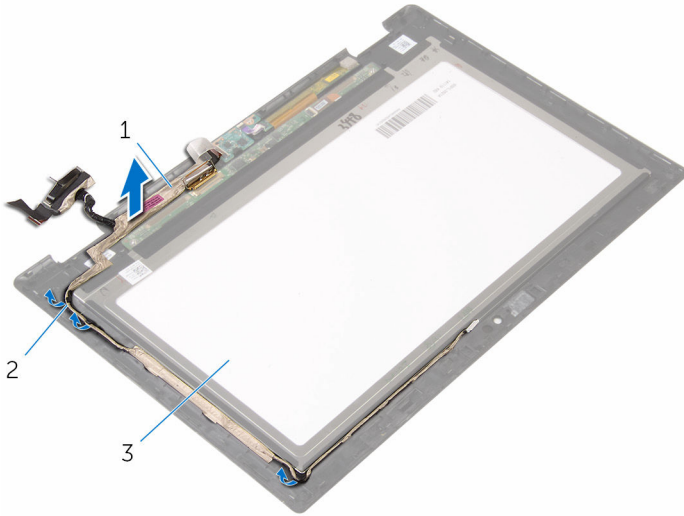

1 display cable

2 routing guides

3 display panel

# Replacing the display cable

---



**WARNING:** Before working inside your computer, read the safety information that shipped with your computer and follow the steps in [Before working inside your computer](#). After working inside your computer, follow the instructions in [After working inside your computer](#). For more safety best practices, see the Regulatory Compliance home page at [dell.com/regulatory\\_compliance](http://dell.com/regulatory_compliance).

## Procedure

- 1 Route the display cable through the routing guides on the display bezel and adhere the display cable on the display bezel.
- 2 Slide the display cable into the connector on the touch board and press down the latch to secure the cable.
- 3 Slide the Windows-button board cable into the connector on the Windows-button board and press down the latch to secure the cable.
- 4 Adhere the adhesive tape on the Windows-button board connector.

## Post-requisites

- 1 Replace the [camera](#).
- 2 Replace the [display back-cover and antenna assembly](#).
- 3 Replace the [display assembly](#).
- 4 Replace the [battery](#).
- 5 Replace the [base cover](#).

# Removing the display panel

---



**WARNING:** Before working inside your computer, read the safety information that shipped with your computer and follow the steps in [Before working inside your computer](#). After working inside your computer, follow the instructions in [After working inside your computer](#). For more safety best practices, see the Regulatory Compliance home page at [dell.com/regulatory\\_compliance](http://dell.com/regulatory_compliance).

## Prerequisites

- 1 Remove the [base cover](#).
- 2 Remove the [battery](#).
- 3 Remove the [display assembly](#).
- 4 Remove the [display back-cover and antenna assembly](#).
- 5 Remove the [camera](#).
- 6 Remove the [display cable](#).

## Procedure

After performing the steps in the prerequisites we are left with the display panel.



1 display panel

# Replacing the display panel

---



**WARNING:** Before working inside your computer, read the safety information that shipped with your computer and follow the steps in [Before working inside your computer](#). After working inside your computer, follow the instructions in [After working inside your computer](#). For more safety best practices, see the Regulatory Compliance home page at [dell.com/regulatory\\_compliance](http://dell.com/regulatory_compliance).

## Procedure

Place the display panel on a clean and flat surface.

## Post-requisites



- 1 Replace the [display cable](#).
- 2 Replace the [camera](#).
- 3 Replace the [display back-cover and antenna assembly](#).
- 4 Replace the [display assembly](#).
- 5 Replace the [battery](#).
- 6 Replace the [base cover](#).



# Flashing the BIOS

---

You may need to flash (update) the BIOS when an update is available or when you replace the system board. To flash the BIOS:

- 1 Turn on the computer.
- 2 Go to **dell.com/support**.
- 3 Click **Product Support**, enter the Service Tag of your laptop and click **Submit**.
  -  **NOTE:** If you do not have the Service Tag, use the auto-detect feature or manually browse for your computer model.
- 4 Click **Drivers & downloads**.
- 5 Scroll down the page and select **BIOS** from the **Category** drop-down list.
  -  **NOTE:** In the **Change OS** drop-down list, select the operating system installed on your computer.
- 6 Expand **BIOS** to view the available BIOS files.
- 7 Click **Download File** to download the latest version of the BIOS for your computer.
- 8 Save the file and once the download is complete, navigate to the folder where you saved the BIOS update file.
- 9 Double-click the BIOS update file icon and follow the instructions on the screen.

# Getting help and contacting Dell

---

## Self-help resources

You can get information and help on Dell products and services using these online self-help resources:

Self-Help Information	Self-Help Options
Accessing Windows Help	<b>Windows 8.1</b> —Open the Search charm, type <b>Help and Support</b> in the search box, and press <b>Enter</b> . <b>Windows 7</b> —Click <b>Start</b> → <b>Help and Support</b> .
Information about Dell products and services	See <b>dell.com</b> .
Troubleshooting information, user manuals, setup instructions, product specifications, technical help blogs, drivers, software updates, and so on	See <b>dell.com/support</b> .
Information about Microsoft Windows 8.1	See <b>dell.com/windows8</b> .
Information about Microsoft Windows 7	Click <b>Start</b> → <b>All Programs</b> → <b>Dell Help Documentation</b> .
Learn about your operating system, setting up and using your computer, data backup, diagnostics, and so on.	See <i>Me and My Dell</i> at <b>dell.com/support/manuals</b> .

## Contacting Dell

To contact Dell for sales, technical support, or customer service issues, see **dell.com/contactdell**.



**NOTE:** Availability varies by country and product, and some services may not be available in your country.



**NOTE:** If you do not have an active internet connection, you can find contact information on your purchase invoice, packing slip, bill, or Dell product catalog.